

SAMPO

DR-S0426 / DRE-S0426P
4 Channel Stand-alone
Digital Video Recorder



INSTRUCTION MANUAL

To obtain the best performance and ensure device function correctly, please read this instruction manual carefully and completely.
FCC Compliance

USER-INSTALLER CAUTION: YOUR AUTHORITY TO OPERATE THIS FCC VERIFIED EQUIPMENT COULD BE VOIDED IF YOU MAKE CHANGES OR MODIFICATIONS NOT EXPRESSLY APPROVED BY THE PARTY RESPONSIBLE FOR COMPLIANCE TO PART 15 OF THE FCC RULES.

NOTE: THIS EQUIPMENT HAS BEEN TESTED AND FOUND TO COMPLY WITH THE LIMITS FOR A CLASS A DIGITAL DEVICE, PURSUANT TO PART 15 OF THE FCC RULES. THESE LIMITS ARE DESIGNED TO PROVIDE REASONABLE PROTECTION AGAINST HARMFUL INTERFERENCE WHEN THE EQUIPMENT IS OPERATED IN A COMMERCIAL ENVIRONMENT. THIS EQUIPMENT GENERATES, USES, AND CAN RADIATE RADIO FREQUENCY ENERGY AND IF NOT INSTALLED AND USED IN ACCORDANCE WITH THE INSTRUCTION MANUAL, MAY CAUSE HARMFUL INTERFERENCE TO RADIO COMMUNICATIONS.

OPERATION OF THIS EQUIPMENT IN A RESIDENTIAL AREA IS LIKELY TO CAUSE HARMFUL INTERFERENCE IN WHICH CASE THE USER WILL BE REQUIRED TO CORRECT THE INTERFERENCE AT HIS OWN EXPENSE.



THIS CLASS A DIGITAL APPARATUS MEETS ALL REQUIREMENTS OF THE CANADIAN INTERFERENCE-CAUSING EQUIPMENT REGULATIONS.

WARNINGS, CAUTIONS & COPYRIGHT



WARNINGS

TO REDUCE THE RISK OF FIRE OR ELECTRIC SHOCK, DO NOT EXPOSE THIS PRODUCT TO RAIN OR MISTURE.
 DO NOT INSERT ANY METALLIC OBJECT THROUGH VENTILATION GRILLS.

CAUTION

	CAUTION	
RISK OF ELECTRIC SHOCK DO NOT OPEN		
CAUTION: TO REDUCE THE RISK OF ELECTRIC SHOCK. DO NOT REMOVE COVER (OR BACK). NO USER-SERVICEABLE PARTS INSIDE. REFER SERVICING TO QUALIFIED SERVICE		

Explanation of Graphical Symbols

	The lightning flash with arrowhead symbol, within an equilateral triangle, is intended to alert the user to the presence of insinuated "dangerous voltage" within the products enclosure that may be of sufficient magnitude to constitute a risk of electric shock to persons.
	The exclamation point within an equilateral rhombus is intended to alert the user to the presence of important operating and maintenance (servicing) instruction in the literature accompanying the product.

USERS OF THE SYSTEM ARE RESPONSIBLE FOR CHECKING AND COMPLYING WITH ALL FEDERAL, STATE, AND LOCAL LAWS AND STATUTES COIPCERNING THE MONITORING AND RECORDING OF VIDEO AND AUDIO SIGNALS. ULTRAK SHALL NOT BE HELD RESPONSIBLE FOR THE USE OF THIS SYSTEM IN VIOLATION OF CURRENT LAWS AND STATUTES.

COPYRIGHT

THE TRADEMARKS MENTIONED IN THE MANUAL ARE LEGALLY REGISTERED TO THEIR RESPECTIVE COMPANIES.

TABLE OF CONTENTS

INDEX - TABLE OF CONTENTS-----	1
SETUP MENU LIST-----	2
CHAPTER 1 INTRODUCTION / FEATURE-----	3
CHAPTER 2 HARDWARE OVERVIEW -----	4
CHAPTER 3 SETUP PROCEDURES -----	7
0. LIVE VIEWING-----	7
1. MAIN MENU SETUP -----	7
2. SYSTEM SETUP -----	8
3. CAMERA SETUP -----	9
4. RECORD SETUP -----	10
5. ALARM SETUP-----	11
6. SCHEDULED RECORD -----	12
7. EVENT LIST -----	12
8. HDD MANAGEMENT -----	13
9. LOAD DEFAULT -----	15
10. EXIT -----	15
CHAPTER 4 OPERATION PROCEDURES -----	16
1. GETTING STARTED WITH YOUR MACHINE -----	16
2. RECORDING -----	16
3. PLAYBACK -----	16
4. HARD DISK AND CF CARD RECOMMEND -----	19
5. VCR -----	19
6. ALARM CONTROL -----	19
7. EXTERNAL ALARM CONNECTOR -----	20
8. VGA OUTPUT -----	21
9. RS-485 CONTROL PROTOCOL-----	22
CHAPTER 5 SPECIFICATIONS -----	23
CHAPTER 6 RECORDING TIME LENGTH -----	24
CHAPTER 7 HARD DRIVE INSTALLATION PROCEDURES -----	25

S2.21 2006/JAN/16

a11633RM4F17

SETUP MENU List

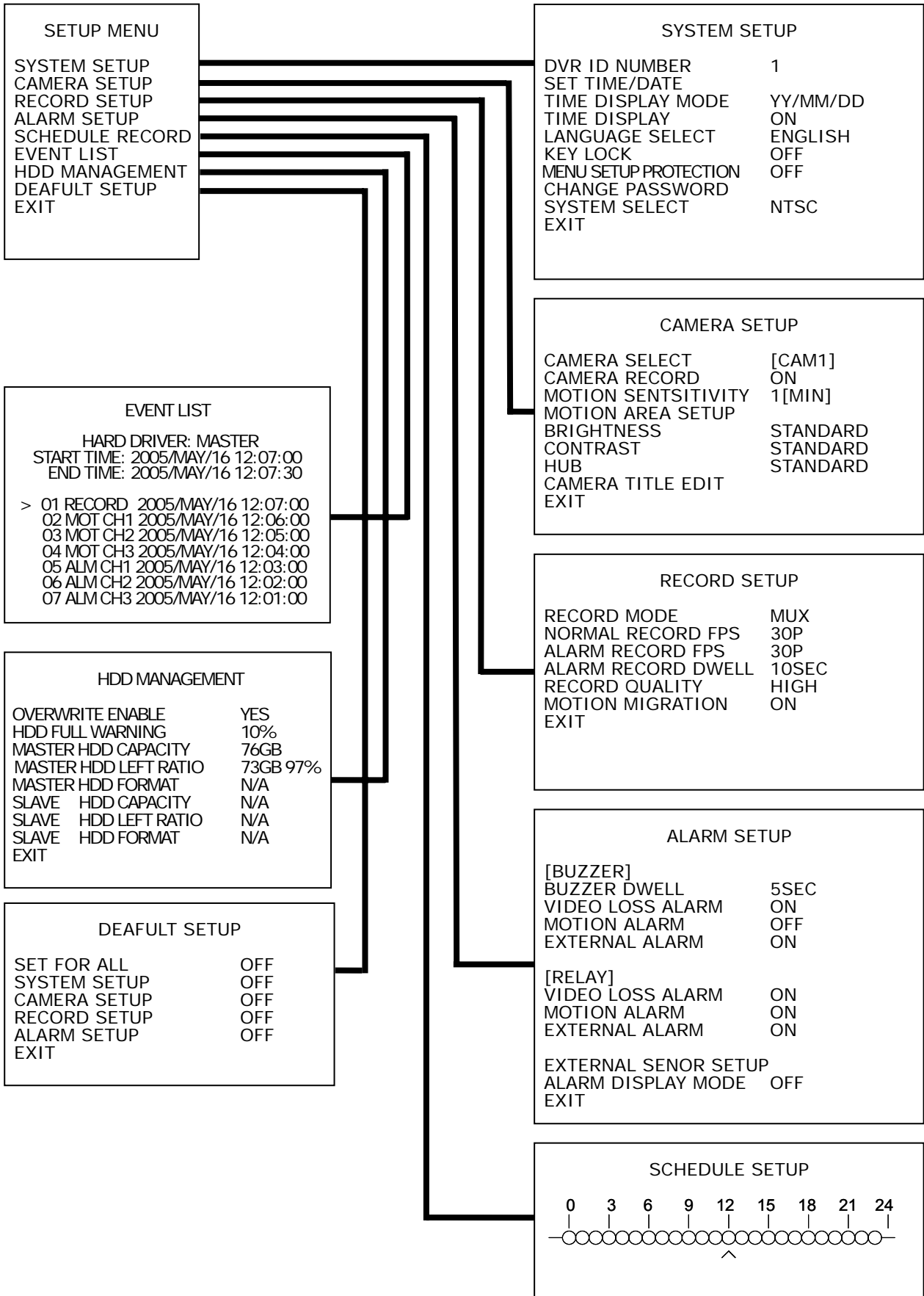

CHAPTER 1

INTRODUCTION

This product is 4 cameras input appliance with multiple function which will bring you following features:

- Device can be performed as VHS system with live display, play back and video recording.
- Device operates in hardware base with no OS (operating system) necessary for more reliability and stability.
- Digitize data storage with M-JPEG compression technology will give you organized video data management without using mess huge traditional video tape.
- Support various type of camera with real, live mode display.
- Multi-speed recording selection on normal recording mode or alarm recording mode, the highest speed of recording is 30/25 (NTSC/PAL) fields on both mode.
- **Title**, contrast, hue and brightness are adjustable for each camera individually.
- Support up to 2 hard disks (HDD) from 40GB to 400GB compatible & **status indicator on screen**.
- When external alarm is triggered, corresponding cameras number will show up on the monitor with texts.
- Selectable recording qualities (best/high/medium/low).
- Recording can operate manually or gets activated automatically when alarm is triggered.
- Motion detection function available, user can easily adjust sensitive & **area** of motion detection.
- Playback record can be searched by time or by event list.
- Play back mode could not be easier then ever for you to review the video that gets recorded on reverse (x16) and fast forwarding (x4, x8, and x16).
- Play back mode with pause (field by field) for forward.
- Easy operation, setting can be easily modified OSD (on screen display) menu.
- Device will overwrite data and notice operator on monitor when the HDD is going full.
- HDD capacity status can be show on the screen for better storage management.
- System will restore the previous setting and continue camera activity after restart.
- Provide 2 Monitor output & optional VGA output function.
- Alarm notification could be sent via email when motion or external alarms are triggered.
- **Optional audio function.**
- **Date type selectable.**
- **Support DVR ID setting for joystick control panel.**
- **NTSC/PAL switching by OSD menu.**
- **External Alarm NO/NC Selection & Individual Relay On/Off Selection.**
- **Advanced buzzer control.**
- **Force recording under schedule recording in no record mode.**
- **Password & key lock protect even power lose.**

***New function in boldface**





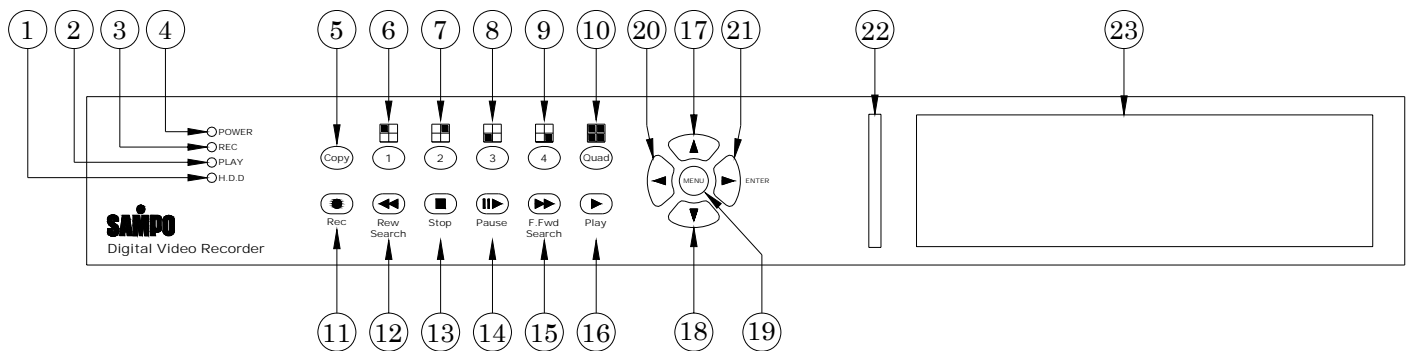



CHAPTER 2 Hardware Overview







Front Panel Layout Overview



Buttons Function List

1. DVR ESSENTIAL OPERATION

Part	Label	Function
1	POWER	Power status LED.
2	REC	Recording status LED.
3	PLAY	Playback status LED.
4	H.D.D	H.D.D LED
5	 REC	Press REC to start recording.
6	 1	<ol style="list-style-type: none"> This View button controls FULL SCREEN display from camera 1. A password can be setup by the view control button for number 1.
7	 2	<ol style="list-style-type: none"> This View button controls FULL SCREEN display from camera 2. A password can be setup by the view control button for number 2.
8	 3	<ol style="list-style-type: none"> This View button controls FULL SCREEN display from camera 3. A password can be setup by the view control button for number 3.
9	 4	<ol style="list-style-type: none"> This View button controls FULL SCREEN display from camera 4. A password can be setup by the view control button for number 4.
10	 Quad	Quad screen: All cameras are displayed.
11	COPY	CF or CDRW Backup button.
12	 Rew Search	16 times speed fast rewind mode.
13	 STOP	Press Stop to stop playback or recording.

14	 Pause	Press Pause to pause (field by field) for forward.
15	 F.Fwd Search	Press F. Fwd to play video forward at high speed. Press the button again the speed will be change circulative from $\times 2$, $\times 4$, to the highest $\times 8$.
16	 PLAY	Press the Play button to into time search and play video forward.
17		<ol style="list-style-type: none"> 1. Move the cursor upward or decrease the number. 2. When it's not under recording mode, you can use the button to adjust position of date & time display which appears on OSD.
18		<ol style="list-style-type: none"> 1. Move the cursor downward or increase the number. 2. When it's not under recording mode, you can use the button to adjust position of date & time display which appears on OSD
19	MENU	Press MENU to go into or exit menu.
20	 (ENTER)	<ol style="list-style-type: none"> 1. Press ENTER button to choose or confirm in MENU system. 2. You can use ENTER key to indicates H.D.D status when system is not under Menu mode.
21	 (ENTER)	<ol style="list-style-type: none"> 3. Make any changes in the selected option or decrease/increase the number.
22	CF Card	Slot for compact flash (CF) card. (Option)
23	HDD/CDRW	Removable HDD or CDRW. (Option)

Back Panel Layout Overview

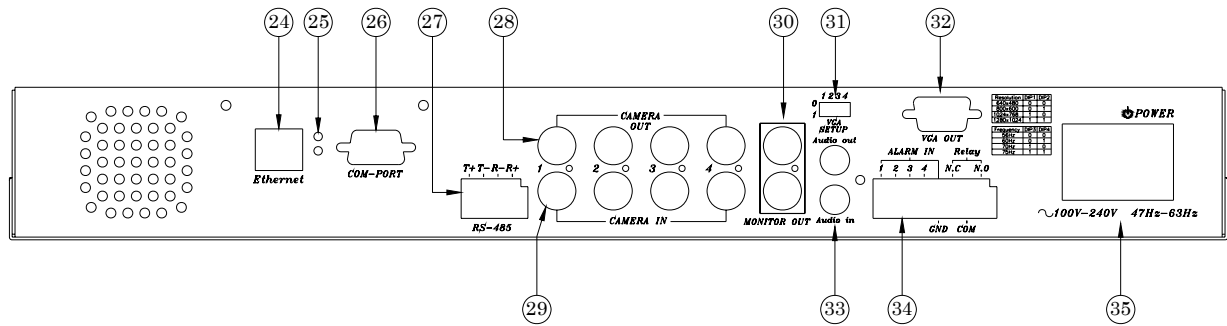

2. Back Panel Components Function List

Part	Label	Function
24	ETHERNET	Reserved
25	LED	Reserved
26	COM PORT	COM port for RS-485 interfaces which upon to request.
27	RS-485 header	4 pin Terminal. For external control of unit.
28	CAMERA OUT	Camera 1-4 video output with BNC connector.
29	CAMERA IN	Camera 1-4 video input with BNC connector.
30	MONITOR OUT	Composite video output with 2 BNC connectors.
31	VGA SETUP DIP	Setting Resolution & Frequency. (Option)
32	VGA D-SUB OUT	Connect to CRT or LCD monitor. (Option)
33	Audio IN / OUT	Audio input / output RCA connectors. (Option)
34	ALARM IN / Relay	8-Pin Alarm input and Relay output connector.
35	POWER / POWER SW	AC100V~AC240V, Frequency 47-63Hz input. Power ON/OFF switcher.

CHAPTER 3 SETUP PROCEDURES

0. LIVE VIEWING

REC 30P 2005/MAY/16 10:20:30 MON	←----- STATUS BAR
MOT [CAM1]O O[CAM2] [CAM3]O O[CAM4]	
[M] 231GB/239GB 97% [S] N/A	←----- INFORMATION BAR

STATUS BAR

Press ▲ button move from top or downgrade a line, and how many recording FPS will show on the left upper corner.

INFORMATION BAR

Press ▼ button move from bottom or upgrade a line, by ◀ or ▶ button to change information between HARD DISK STSTATUS, RECORDING MODE and AUDIO RECORDING STATUS.

While MENU mode without press any key would go back to live viewing mode after 2 minutes. And during live viewing for 5 seconds would go back to recording mode automatically, if full time or alarm record set before.

1. MAIN SETUP MENU

SETUP MENU
SYSTEM SETUP
CAMERA SETUP
RECORD SETUP
ALARM SETUP
SCHEDULE RECORD
EVENT LIST
HDD MANAGEMENT
DEAFULT SETUP
EXIT

Press the **MENU** button to go into the main menu.

Use the ▲ or ▼ button to select items.

Press the ◀ or ▶ button to confirm the selection.

Press **MENU** to escape to exit the set up mode.

1. **SYSTEM SETUP**

System set up.

2. **CAMERA SETUP**

Camera set up.

3. **RECORD SETUP**

Recording set up.

4. **ALARM SETUP**

Alarm set up.

5. **SCHEDULE RECORD**

Schedule Recording set up.

6. **EVENT LIST**

Recording event list

7. **HDD MANAGEMENT**

Hard disk management

8. **DEAFULT SETUP**

Return to factory setting

9. **EXIT**

Escape from the setup menu.

2. SYSTEM SETUP

SYSTEM SETUP	
DVR ID NUMBER	1
SET TIME/DATE	
TIME DISPLAY MODE	YY/MM/DD
TIME DISPLAY	ON
LANGUAGE SELECT	ENGLISH
KEY LOCK	OFF
MENUSETUPPROTECTION	OFF
CHANGE PASSWORD	
SYSTEM SELECT	NTSC
EXIT	

Press ▲ or ▼ key on "SYSTEM SETUP" & ◀ or ▶ to enter:

Use the ▲ or ▼ button to select items.

Press the ◀ or ▶ button to confirm the selection.

Press MENU back to SETUP MENU.

1. **DVR ID NUMBER** **1~32**

Use ◀ or ▶ button to set up DVR ID for extension keyboard. Range from 1 to 32.

2. **SET TIME/DATE**

Use ◀ or ▶ button to move, ▲ or ▼ button to set up date & time, by **MENU** key back to menu.

3. **TIME DISPLAY MODE**

Use ◀ or ▶ button to change YY/MM/DD, MM/DD/YY or DD/MM/YY.

4. **TIME DISPLAY** **ON/OFF**

Use ◀ or ▶ button to change ON or OFF.

5. **LANGUAGE SELECT** **ENGLISH**

Use ◀ or ▶ button to change language.

6. **KEY LOCK** **ON/OFF**





Use ◀ or ▶ button to change ON or OFF.

7. **MENU SETUP PROTECT** **ON/OFF**

Use ◀ or ▶ button to change ON or OFF.

8. **CHANGE PASSWORD**

Key in password with following sequence CURREBT PASSWORD -> NEW PASSWORD -> CONFIRM PASSWORD. Initial number is 1111. Use the view control button on the

front panel to input the number.  is "1" ,  is "2" ,  is "3" ,  is "4"

9. **SYSTEM SELECT** **NTSC/PAL**

Use ◀ or ▶ button to change NTSC or PAL video system.

3. CAMERA SETUP

CAMERA SETUP	
CAMERA SELECT	[CAM1]
CAMERA RECORD	ON
MOTION SENSITIVITY	1[MIN]
MOTION AREA SETUP	
BRIGHTNESS	STANDARD
CONTRAST	STANDARD
HUB	STANDARD
CAMERA TITLE EDIT	
EXIT	

Press ▲ or ▼ key on "CAMERA SETUP" & ◀ or ▶ to enter:

Use the ▲ or ▼ button to select items.

Press the ◀ or ▶ button to confirm the selection.

Press MENU back to SETUP MENU.

1. CAMERA SELECT CAM1/CAM2/CAM3/CAM4

Use ◀ or ▶ button to select the camera from CH1 – CH4 to be adjusted.

2. CAMERA RECORD ON/OFF

Use ◀ or ▶ button to select recording function ON or OFF.

3. MOTION SENSITIVITY OFF / 1[MIN] / 2 / 3 / 4 / 5[MAX]

Use ◀ or ▶ button to adjust the sensitivity of the selected camera. From 0 (off) to 5 (MAX).

4. MOTION AREA SETUP

Use ◀ or ▶ button to enter motion area setup, here provide 2 areas for setting.

[PLAY] to change the position or area mode.

[▲ ▼ ◀ ▶] to moving position or change area size.

[CH1] for default minimum size.

[CH2] for default size.

[CH3] for default maximum.

[QUAD] for help information on screen.

[MENU] back to pervious menu.

5. BRIGHTNESS 1 / 2 / 3 / 4 /STANDARD/ 6 / 7 / 8 / 9 /10

Use ◀ or ▶ button to adjust the brightness of the selected camera. Initial number is 5 (STANDARD).

6. CONTRAST 1 / 2 / 3 / 4 /STANDARD/ 6 / 7 / 8 / 9 /10

Use ◀ or ▶ button to adjust the contrast of the selected camera. Initial number is 5 (STANDARD).

7. HUB 1 / 2 / 3 / 4 /STANDARD/ 6 / 7 / 8 / 9 /10

Use ◀ or ▶ button to adjust the hue of the selected camera. Initial number is 5 (STANDARD).

8. CAMERA TITLE EDIT

Use ◀ or ▶ button to enter camera title edit mode, support up to 7 character each.

4. RECORD SETUP

RECORD SETUP	
RECORD MODE	MUX
NORMAL RECORD FPS	30P
ALARM RECORD FPS	30P
ALARM RECORD DWELL	10SEC
RECORD QUALITY	HIGH
MOTION MIGRATION	ON
EXIT	

Press ▲ or ▼ key on "RECORD SETUP" & ◀ or ▶ to enter:

Use the ▲ or ▼ button to select items.

Press the ◀ or ▶ button to confirm the selection.

Press MENU back to SETUP MENU.

1. **RECORD MODE** **MUX/QUAD**

Use ◀ or ▶ button to select MUX (multiplexer) or OD (QUAD) recording.

NORMAL RECORD FPS **1/2/3/4/5/7/10/15 & 30P**

Use ◀ or ▶ button to select recording speed. 15P means 15 fields per second, 30P is the highest speed, and 1P is the lowest. There are 1 / 2 / 3 / 4 / 5 / 7 / 10 / 15 & 30 you can choose, NTSC default 15P, PAL at 12P.

2. **ALARM RECORD FPS** **1/2/3/4/5/7/10/15 & 30P**

Use ◀ or ▶ button to select alarm recording speed when external alarm or motion detection is triggered. There are 1 / 2 / 3 / 4 / 5 / 7 / 10 / 15 & 30 you can choose, NTSC default 30P, PAL at 25P.

3. **ALARM RECORD DWELL** **1~30SEC**

Use ◀ or ▶ button to set the dwell time for alarm recording when external alarm or motion detection is triggered. There are a total of 30 speeds you can choose from 1 to 30. When external alarm is triggered and within the dwell period: the screen will be switched into quad mode. The corresponding camera will be marked ID "EXT" or "ALM", default 10 seconds..

4. **RECORD QUALIT** **BEST/HIGH/MEDIUM/LOW**

Use ◀ or ▶ button to select the BEST, HIGH, MEDIUM or LOW setting so there is a total of four levels of recording quality that can be chosen from. Higher quality & higher the amount of storage will be consumed. Thus, this setting should be carefully chosen as it will affect the usage of hard disk storage. A table at cheap 6 for relationship between quality, recording speed and hard disks is attached for reference.

5. **MOTION MIGRATION** **ON**

Use ◀ or ▶ button to select add detected motion into event list or not, and the default setting is on

5. ALARM SETUP

ALARM SETUP	
[BUZZER]	
BUZZER DWELL	5SEC
VIDEO LOSS ALARM	ON
MOTION ALARM	OFF
EXTERNAL ALARM	ON
[RELAY]	
VIDEO LOSS ALARM	ON
MOTION ALARM	ON
EXTERNAL ALARM	ON
EXTERNAL SENOR SETUP	
ALARM DISPLAY MODE	OFF
EXIT	

Press ▲ or ▼ key on "ALARM SETUP" & ◀ or ▶ to enter:

Use the ▲ or ▼ button to select items.

Press the ◀ or ▶ button to confirm the selection.

Press **MENU** to go back to SETUP MENU.

[BUZZER]

1. BUZZER DWELL 1/2/3 to 30 SEC & CONT

Use ◀ or ▶ button to set the dwell time for buzzer issue occur. There are a total of 31 periods you can choose from 1 to 30 seconds or "CONT" for constantly.

2. VIDEO LOSS ALARM ON/OFF

Use ◀ or ▶ button to select video loss alarm function on or off.

3. MOTION ALARM ON/OFF

Use ◀ or ▶ button to switch function on or off when motion occur.

4. EXTERNAL ALARM ON/OFF

Use ◀ or ▶ button to switch function on or off when external alarm occurs.

[RELAY]

1. VIDEO LOSS ALARM ON/OFF

Use ◀ or ▶ button to switch video loss alarm function form relay box.

2. MOTION ALARM ON/OFF

Use ◀ or ▶ button to switch motion alarm function form relay box.

3. EXTERNAL ALARM ON/OFF

Use ◀ or ▶ button to switch external alarm function form relay box.

EXTERNAL SENOR SETUP

EXTERNAL SENSOR SETUP	
CHANNEL-1	OFF
CHANNEL-2	NORMAL-OPEN
CHANNEL-3	NORMAL-CLOSE
CHANNEL-4	OFF
EXIT	

Use the ▲ or ▼ button to select channel.

Press the ◀ or ▶ button to change alarm type.

Press **MENU** to go back pervious menu.

Each channel with 3 types for selection:

1. OFF
2. NORMAL-OPEN (DEFAULT)
3. NORMAL-CLOSE

ALARM DISPLAY MODE ON/FF

During recording & full channel mode, if ALARM DISPLAY MODE is ON, system would switch to the ALARM or MOTION channel and the period depend on ALARM RECORD DWELL.

6. SCHEDULE RECORD

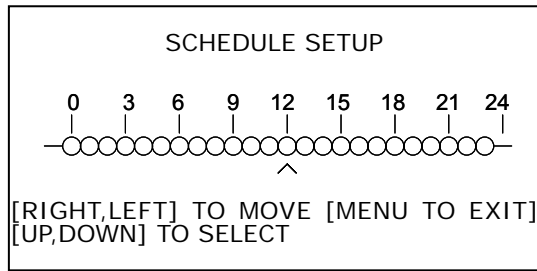

Press ▲ or ▼ key on "SCHEDULE RECORD" & ◀ or ▶ to enter:

Use the ◀ or ▶ button to select items.

Press the ▲ or ▼ button to confirm the selection.

Press **MENU** to go back to SETUP MENU.

There are 24 circles in the schedule table, which represent 24 hours.

Every circle has 3 options to select:

O : represents "fully record"

X : represents "no record"

A : represents "alarm record"

Use the ◀ or ▶ button to select hours.

Press ▲ or ▼ button to select the **O / X / A** (Fully / No / Alarm Record).

QUICK KEY:

▶ **Play** Key to switch between **O / X / A** (Fully / No / Alarm Record) in all hours.

7. EVENT LIST

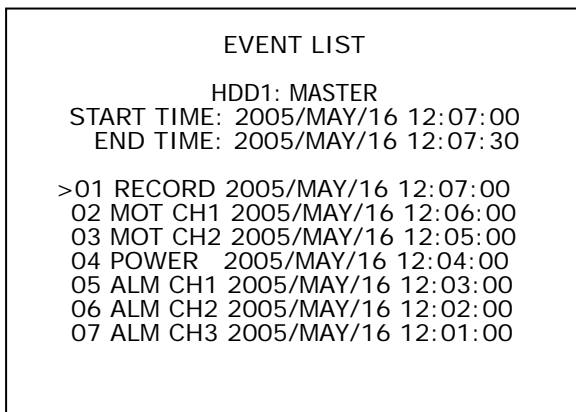

Press ▲ or ▼ key on "EVENT LIST" & ◀ or ▶ to enter:

Use the ◀ or ▶ button to select items.

Press the ▲ or ▼ button to confirm the selection.

Press **MENU** back to SETUP MENU.

Use "▲ or ▼" key to select event which needs to be played, location of ">" symbol will move up and down for indicating current event which been selected.

Press "◀ or ▶" key to select events storage from master hard drive or slave hard drive.

When once selection has been made and then press **▶PLAY** key to start playback.

There are totally 4 different type's event will be recorded:

1. RECORD : Event starts recording by press "REC" key.
2. POWER : **When power off or loss, system would add this issue, and "POWER ERROR DETECTED" would show on screen while boot.**
3. ALM CH1 : When external alarm was triggered, event up with alarm number.
4. MOT CH1 : When motion detection was triggered, event up with alarm number.

Record setup "MOTION EVENT MIGRATION" must at ON.

In the period of alarm record triggered constantly that the a single EVENT LIST item will be extend while lapsed, thus ENET LIST would show the first triggered channel number on the list and the recording seconds will be extended .

8. HDD MANAGEMENT

HDD MANAGEMENT			
OVERWRITE ENABLE			YES
HDD FULL WARNING	10%		
MASTER HDD CAPACITY	76GB		
MASTER HDD LEFT RATIO	73GB	97%	
MASTER HDD FORMAT	N/A		
SLAVE HDD CAPACITY	N/A		
SLAVE HDD LEFT RATIO			N/A
SLAVE HDD FORMAT	N/A		
EXIT			

Press ▲ or ▼ key on "NETWORK SETUP" & ◀ or ▶ to enter:

Use the ◀ or ▶ button to select items.

Press the ▲ or ▼ button to confirm the selection.

Press **MENU** back to SETUP MENU.

1. **OVERWRITE MODE** **YES (YES/NO)**

Use "◀ or ▶" button to enable or disable overwriting when HDD is full. When HDD overwrite is enabled, the oldest partition on HDD will automatically be reused, and the oldest images will be overwritten the current images. When overwrite mode is disabled, the HDD Full Warning percentage selection will be appeared and need to be configured.

2. **HDD FULL WARNING** **10% (5% / 10% / 15% / 20%)**

Use "◀ or ▶" button to select one of the four settings (5% / 10% / 15% / 20%). The default is 10%. The buzzer will turn on when free space left in the HDD go below the set value and alarm again when the total free space left going down each 5%.

3. **MASTER HDD CAPACITY** **76GB**

The master HDD capacity will be indicated on the screen, it can't be revised.

4. **MASTER HDD LEFT RATIO** **73GB 97%**





The master HDD left ratio sign will be indicated on the screen, it can't be revised.

5. **MASTER HDD FORMAT**

Use "◀ or ▶" button to enter the **MASTER HDD FORMAT** menu.

PASSWORD INPUT : _ _ _ _

Use the view control button on the front panel to input the number.

 is "1" ,  is "2" ,  is "3" ,  is "4"

When you key in the correct password, the screen will be displayed the following message:

PASSWORD CORRECT!

HARD DISK FORMATTED

Otherwise, the following error message will be displayed on the screen:

PASSWORD INCORRECT!

CHANGE PASSWORD:

Please refer to page 2 SYSTEM SETUP ->CHANGE PASSWORD.

6. SLAVE HDD CAPACITY N/A

The slave HDD capacity sign will be indicated on the screen, it can't be revised. HDD N/A is with no HDD.

7. SLAVE HDD LEFT RATIO N/A

The slave HDD left ratio sign will be indicated on the screen, it can't be revised. HDD N/A is with no HDD.

8. SLAVE HDD FORMAT

Same with MASTER HDD FORMAT.

9. LOAD DEFAULT

DEAFULT SETUP	
SET FOR ALL	OFF
SYSTEM SETUP	OFF
CAMERA SETUP	OFF
RECORD SETUP	OFF
ALARM SETUP	OFF
EXIT	

Press ▲ or ▼ key on "DEAFULT SETUP" & ◀ or ▶ to enter:

Use the ◀ or ▶ button to select items.

Press the ▲ or ▼ button to confirm the selection.

Press MENU back to SETUP MENU.

1. **SET FOR ALL** **ON/OFF**

Use ◀ or ▶ button to change all item in ON , OFF or "---" by individual

2. **SYSTEM SETUP** **ON/OFF**

Use ◀ or ▶ button to ON for restore to default setting or OFF.

3. **CAMERA SETUP** **ON/OFF**

Use ◀ or ▶ button to ON for restore to default setting or OFF.

4. **RECORD SETUP** **ON/OFF**

Use ◀ or ▶ button to ON for restore to default setting or OFF.

5. **ALARM SETUP** **ON/OFF**

Use ◀ or ▶ button to ON for restore to default setting or OFF.

6. **CONFIRM AND EXIT**

After setting above items and press◀ or ▶ button back to default setup, otherwise by **MENU** key back to main menu.

While changed setting & exit DEAFALUT, a dialog would show up and ask to confirm the setting.

ARE YOU SURE...
>NO
YES

10. EXIT

Exit from the **SETUP MENU**.

CHAPTER 4

OPERATION PROCEDURES

1 Getting Started with your machine

Please assure the following instructions before you switch on the machine:

1.1 Voltage check: Before power cable is connected, please check the voltage of this appliance against the supply.

Input voltage range 100~240V, frequency range 47-63Hz.

CAUTION - Damage would be caused if incorrect power voltage applied.

1.2 Hard Disk connection: Make sure the 40-Pin Hard Disk Data cable and the 4-Pin power connectors are properly connected.

2 Recording

2.1 Press the **●REC** key to enter the Recording Mode. And press the **■STOP** key to stop recording.

2.2 On information bar the "MUX" or "QUAD" sign will be indicated on the screen, it means you select MUX or QUAD recording.

2.3 "15P" sign will be indicated in top right corner on the screen, it mean the recording speed you selected. 15P means 15 fields per second.

2.4 "O" sign will be indicated in center corner on the screen, it means the marked channel is recorded.

2.5 For more information on Setting up Recording Mode, refer to Chapter 3 Record Setup

2.6 In Recording Mode, if there is a power failure or power lost for any reasons that cause a shut down of this machine, it will be back to the Recording Mode automatically when power restored.

3 Playback

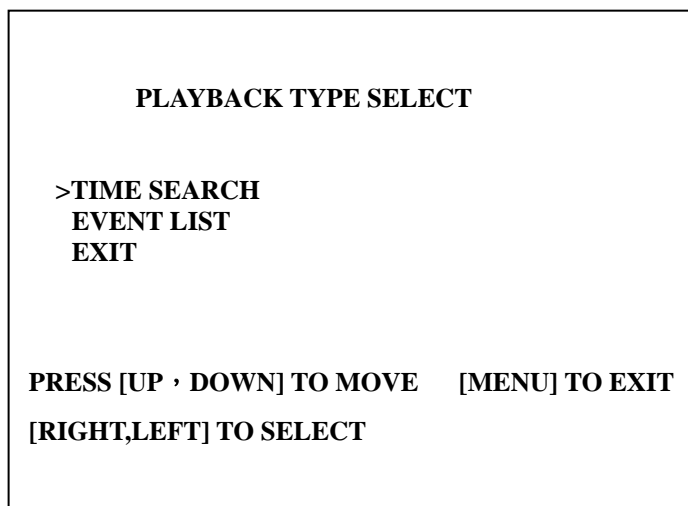

Press the ►PLAY button to into playback mode, There are two ways for searching for video records, use "▲" or "▼" key to select a way for searching, there are two selections "TIME SEARCH" and "EVENT LIST". Arrow mark ">" indicates current selection, press "◀" or "▶" key to start the search.

3.1 Time Search :

```
TIME SEARCH

HDD1: MASTER
START TIME: 2005/MAY/04 08:00:00
^

HARD DRIVE: MASTER
START TIME : 2005/MAY/03 08:12:03
END TIME : 2005/MAY/04 10:10:55

HARD DRIVE: SLAVE
START TIME : N/A
END TIME : N/A

[RIGHT/LEFT] TO MOVE [UP/DOWN] TO CHANGE
[PLAY] TO PLAY [QUAD] CHANGE HDD [MENU] EXIT
```

When entered "TIME SEARCH" mode, by **QUAD** key change hard disk, screen will indicate the earliest record on corresponding hard drive with title "START TIME" and "END TIME". Use "◀" or "▶" keys to setup condition for time search, an arrow mark "^" will show up on corresponding location for adjustment. Use "▲" or "▼" keys to increase or decrease value for search condition on time or date. Press **▶PLAY** key to start playing back.

3.2 Event List :

```
EVENT LIST

HDD1: MASTER
START TIME: 2005/MAY/16 12:07:00
END TIME: 2005/MAY/16 12:07:30

>01 RECORD 2005/MAY/16 12:07:00
02 MOT CH1 2005/MAY/16 12:06:00
03 MOT CH2 2005/MAY/16 12:05:00
04 MOT CH3 2005/MAY/16 12:04:00
05 ALM CH1 2005/MAY/16 12:03:00
06 ALM CH2 2005/MAY/16 12:02:00
07 ALM CH3 2005/MAY/16 12:01:00

PRESS [UP/DOWN] TO MOVE [PLAY] TO PLAY
[QUAD] TO CHANG HDD [MENU] TO EXIT
```

When entered "EVENT LIST" mode, we need to choose a hard drive to start search for recorded data. Use **QUAD** key to choose a hard drive to start. Screen will indicate the event list on corresponding hard drive with the event type, start date & time. Use "▲" or "▼" keys to setup condition for time search, an arrow mark ">" will show up on corresponding location for adjustment. Use "▲" or "▼" keys to select the event item, and press **▶PLAY** key to start playing back.

3.3 Several ways to perform playback:

3.3.1 Press **▶PLAY** button to play video forward.

3.3.2 "PLAY" sign will be indicated in top left corner on the screen.

"MUX or QUAD" sign will be indicated in top right corner on the screen, it means the recording mode you selected.

3.3.3 When playback reaches the vary end of record and "END" will appear.

Press **◀◀Rew Search** button to play video reverse at 16 times speed fast rewind mode.

3.3.4 Press **▶▶F.Fwd Search** button to play video forward at high speed. Press the button again speed will be change circulative from ×4, ×8, to the highest ×16.

3.3.5 "REW" or "FF* 4 / 8 / 16" sign will be indicated in top left corner on the screen.

3.3.6 Press **||▶Pause** button to pause (field by field) for forward. This function can be used in full screen and quad mode.

(If you choose QUAD in recording mode than it can't playback in full single channel screen).

3.3.7 "PAUSE" sign will be indicated in top left corner on the screen.

Press the **■STOP** button to leave playback mode and resume to Live Mode.

When overwrite mode is enabled with 2 hard drives, drive which is overwriting will cause recording time being divided to 2 periods as picture below:

```
TIME SEARCH
HDD1: MASTER
START TIME: 2005/MAY/04 08:00:00
^
HARD DRIVE: MASTER
START TIME : 2005/MAY/05 08:12:03
END TIME : 2005/MAY/05 10:10:55
HARD DRIVE: SLAVE
START TIME : 2005/MAY/03 08:12:03
END TIME : 2005/MAY/04 10:10:55
[RIGHT/LEFT] TO MOVE [UP/DOWN] TO CHANGE
[PLAY] TO PLAY [QUAD] CHANGE HDD [MENU] EXIT
```

There will be 2 periods of time as RECORD SEGMENT 1 and RECORD SEGMENT 2 in master drive which means the oldest data and newest data both existing on the same hard drive. Above rules will also apply to slave hard drive.

4 Hard disk

Maximum 2 pieces and at least one hard disk should be connected, the capacity of hard disk from 40GB to 400GB for each.

When you restart the power of this appliance after install or replace new hard disk it will format automatically, we tested the following model for your reference:

Brand	Model	Capacity	Speed (rpm)
Seagate	ST380011A	80GB	7200 rpm
Seagate	ST3120023A	120GB	7200 rpm
Seagate	ST3160023A	160GB	7200 rpm
Seagate	ST3400832A	400GB	7200 rpm
Maxtor	6Y120L0	120GB	7200 rpm
Maxtor	6Y080L0	80GB	7200 rpm
Maxtor	6Y160P0	160GB	7200 rpm
Maxtor	7Y250P0-A	250GB	7200 rpm

We **DO NOT** suggest Samsung \ Western Digital \ Maxtor DiamondMax 10 series hard drive base on technical examination.

5 VCR

1. VCR Backup

The DVR Provides composite signal output for back-up use. You can keep the Image data, and simply just connected **BNC** connector, at the Back Panel of, with **MONITOR OUT** Connector. Press VCR REC button, after decided what recording data need to keep, during Play-Back Mode.

6 Alarm control

There are three types of alarms that the system can be configured to handle. They are 1.External Alarm, 2.Video Lost Alarm and alarm of 3.Motion Detection.

When alarm are triggered, it changes recording speed to the alarm recording speed. Video Lost alarm is enabled as default and cannot be changed. The buzzer will action and "V.LOSS" sign will be indicated on the screen.

7 External alarm connector

External alarm functions only when DVR has been set under recording mode. 4 input ports to receive signals from external alarm and GND port for termination. When external alarm is triggered, currents will be grounded through GND port to activate the external alarm.

- a. Texts "ALM" will be displayed on OSD corresponding channel.
- b. Relay action.
- c. Recording speed will be switch from normal mode to alarm mode (refer to chapter 4 about recording setting).
- d. If setting "A" has been set in schedule recording, will only perform recording when alarm is triggered during schedule "A" period.

Terminal connector :

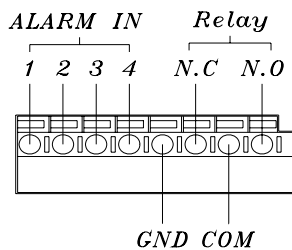

Pin 1-4	-----	ALARM1-ALARM4 , Camera alarm input.
GND	-----	GND
N.C	-----	Relay N.C , Alarm output N.C
COM	-----	Relay COM
N.O	-----	Relay N.O , Alarm output N.O

8 VGA Output

VGA output is optional, please ensure that you have proper DVR model for VGA out put installation. By D-SUB connecter to CRT or LCD monitor, DIP switch definition & suggestion table as below:

Resolution	DIP1	DIP2
640×480	0	0
800×600	0	1
1024×768	1	0
1280×1024	1	1

Frequency	DIP3	DIP4
56Hz	0	0
60Hz	0	1
70Hz	1	0
75Hz	1	1

DIP1	DIP2	DIP3	DIP4	Resolution	Frequency	Monitor
0	0	0	0	640×480	60	15 inch or below
0	0	0	1		72	
0	0	1	0		75	
0	0	1	1			
0	1	0	0	800×600	56	15 inch or below
0	1	0	1		60	
0	1	1	0		72	
0	1	1	1		75	
1	0	0	0	1024×768	60	15~17 inch
1	0	0	1		70	
1	0	1	0		75	
1	0	1	1			
1	1	0	0	1280×1024	60	17 inch or above
1	1	0	1			
1	1	1	0			
1	1	1	1			

9 RS-485 control protocol

Data format

Data: 1 Byte / Parity: None / Start bit: 1 / Baud: 9600

Totally 3 bytes in data frame:

1. Byte=0x10 :Broadcasting DVR
Byte=0x80+ID Number :Remote Control DVR (ID number range: 5~21)
2. Byte=Refer to below table :Command for each key string
3. Byte=First byte plus Second byte :Command for confirm checksum

Part	Label	Command
5	REC	0x21
6	CH1	0x11
7	CH2	0x12
8	CH3	0x13
9	CH4	0x14
10	CHALL	0x15
11	COPY	NONE
12	RFAST	0x3A
13	STOP	0x51
14	PAUSE	0x3D
15	FFAST	0x3E
16	PLAY	0x52
17	UPRT	0x31
18	DNLT	0x32
19	MENU	0x20
20	LEFT	0x33
21	SELECT (ENTER)	0x35

CHAPTER 5

SPECIFICATIONS

Image System		NTSC	PAL
Resolution	Display	720×480	720×576
	Record	640×224	640×272
Video Input		BNC × 4	
Video Looping output		BNC × 4	
Video Output		BNC × 2	
Audio Input (option)		RCA × 1	
Audio Output (option)		RCA × 1	
Display Frame		4 × 30 fields/sec	4 × 25 fields/sec
Recording Frame Rate (QUAD)		Max 30 fps	Max 25 fps
Recording Frame Rate (MUX)		Max 30 / 4 fps	Max 25 / 4 fps
Storage Media		Max 2 IDE Hard Disks / 1 Hard Disk & 1 CDRW	
Image Format		M-JPEG	
Compress Rate		Low : 8K bytes/field High : 15K bytes/field	Medium : 10K bytes/field Best : 20K bytes/field
Recording Mode		Manual / Alarm / Schedule	
Playback Speed		Fast Forward ×4 ×8 ×16 / Fast Reverse ×16 Frame by Frame Forward Playback	
On Screen Display & Setup		Time/Date/Setup Menu	
Alarm Input		×4	
Relay Output		NO or NC Programmable Contact ×1	
Password Control		One for HDD format	
Event List		Max. 63 records/H.D.D	
Motion Detection		Yes	
Buzzer		Yes	
Video loss		Yes	
Key Lock		Yes	
Backup		Optional CF Card / CDRW (Network Function)	
VGA out put		Optional	
Power Input		AC 100-240 V Input (47-64 Hz)	
Voltage		110V 180ma / 220V 95ma	
Dimensions		55mm (H) × 432mm (W) × 321mm (D)	
Weight kg		4.5kg (w/o H.D)	

CHAPTER 6 RECORDING TIME LENGTH

Recording time length is related to recording speed and recording quality. Tables below are offered for your reference.

Record Mode=MUX

Record Mode=QUAD

Recording length under quad mode will shorter than multiplex mode and PAL will shorter than NTSC.

80GB H.D.D Record Mode=MUX										
NTSC Field/Sec		30/FS	15/FS	10/FS	7/FS	5/FS	4/FS	3/FS	2/FS	1/FS
Recording Quality	maximum	38 hr	76 hr	114 hr	160hr	228hr	285hr	380 hr	570 hr	1140hr
	high	57 hr	114Hr	171hr	240hr	342hr	428hr	570 hr	855 hr	1710hr
	medium	71 hr	142hr	213hr	298hr	426hr	532hr	710 hr	1065hr	2130hr
	low	100hr	200hr	300hr	420hr	600hr	750hr	1000hr	1500hr	3000hr

80GB H.D.D Record Mode=QUAD										
NTSC Field/Sec		30/FS	15/FS	10/FS	7/FS	5/FS	4/FS	3/FS	2/FS	1/FS
Recording Quality	maximum	19 hr	38 hr	57 hr	80 hr	114hr	142hr	190hr	285hr	570 hr
	high	29 hr	57 Hr	87 hr	120hr	171hr	214hr	285hr	426hr	870 hr
	medium	35 hr	70 hr	105 hr	148hr	213hr	266hr	350hr	532hr	1050hr
	low	50 hr	100 hr	150 hr	208hr	300hr	375hr	500hr	750hr	1500hr

80GB H.D.D Record Mode=MUX										
PAL Field/Sec		25/FS	12/FS	8/FS	6/FS	4/FS	3/FS	2/FS	1/FS	
Recording Quality	maximum	35 hr	72 hr	110 hr	145 hr	218 hr	291 hr	437 hr	875 hr	
	high	46 hr	95 hr	144 hr	190 hr	287 hr	383 hr	575 hr	1150 hr	
	medium	67 hr	139 hr	209 hr	278 hr	418 hr	558 hr	837 hr	1675 hr	
	low	98 hr	204 hr	306 hr	408 hr	612 hr	816 hr	1225hr	2450hr	

80GB H.D.D Record Mode=QUAD										
PAL Field/Sec		25/FS	12/FS	8/FS	6/FS	4/FS	3/FS	2/FS	1/FS	
Recording Quality	maximum	12 hr	25 hr	37 hr	50 hr	75 hr	100 hr	150 hr	300 hr	
	high	16 hr	33 hr	50 hr	66 hr	100 hr	133 hr	200 hr	400 hr	
	medium	23 hr	48 hr	72 hr	95 hr	143 hr	191 hr	287 hr	575 hr	
	low	34 hr	70 hr	106 hr	141 hr	212 hr	283 hr	425 hr	850 hr	

CF Card Backup time

Capacity= 128M

Single Image file size	Single picture JPEG file	Video clip AVI file
40K	3100 fields	25 minute
50K	2500 fields	20 minute
60K	2000 fields	16 minute

CHAPTER 7

HARD DRIVE INSTALLATION PROCEDURES

1. Hard drive jumpers need to be set properly in order to make DVR function correctly.
2. Instructions below are for second hard drive installation. If you prefer to have only one drive, please ignore instruction below. Remove DVR top cover by taking out screws from location shown below:

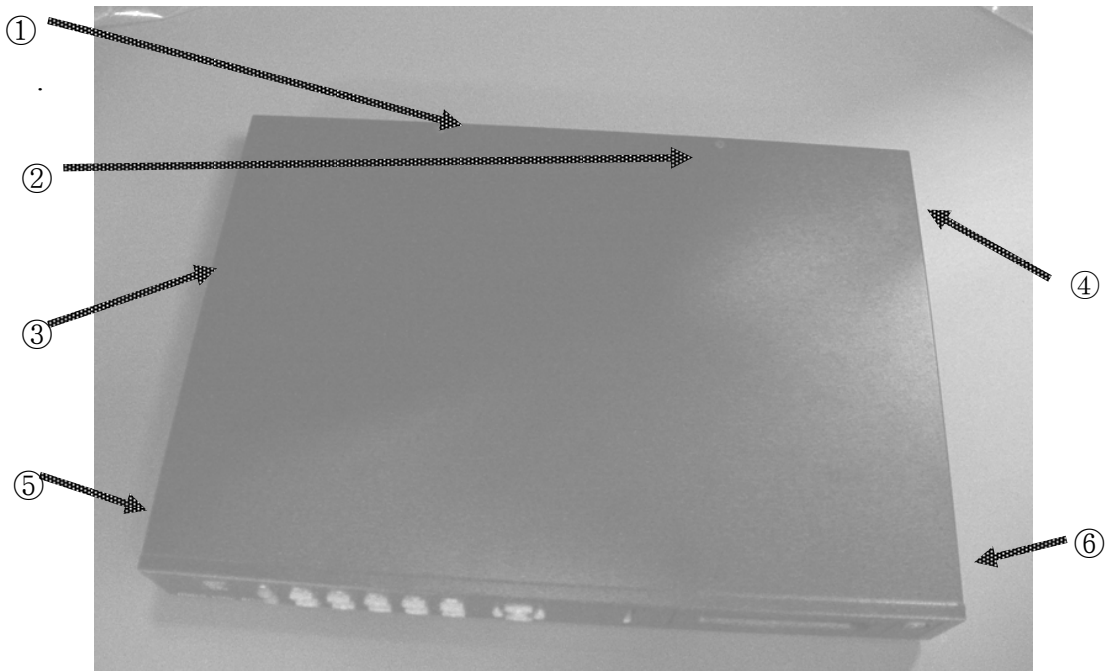

3. Below picture indicates DVR which one without a H.D.D installed.



4. Please refer to the instruction from hard drive manufactory for correct jumper setting on (master /slave) mode of the hard drive, mounting the hard drive over DVR base by facing IDE interface to DVR main board. Match screw holes from bottom to bottom of hard drive and the DVR. Turn over the DVR from top to bottom side and then mounting up the hard drive by using screws from attached accessory pack as picture below:

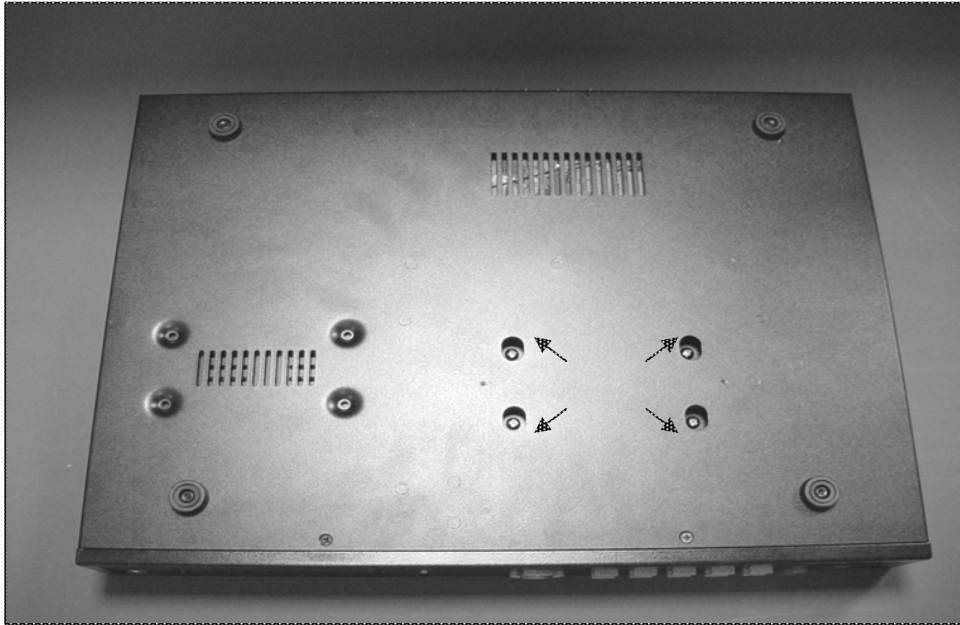

5. Hooking up IDE cable and power cable to the hard drive as picture below, please take a note on that the red line on IDE cable must be next to power cable in order to have correct installation.
6. This DVR supports maxima 2 hard drives, please take a note on cable length that you use to hook up with the hard drive.

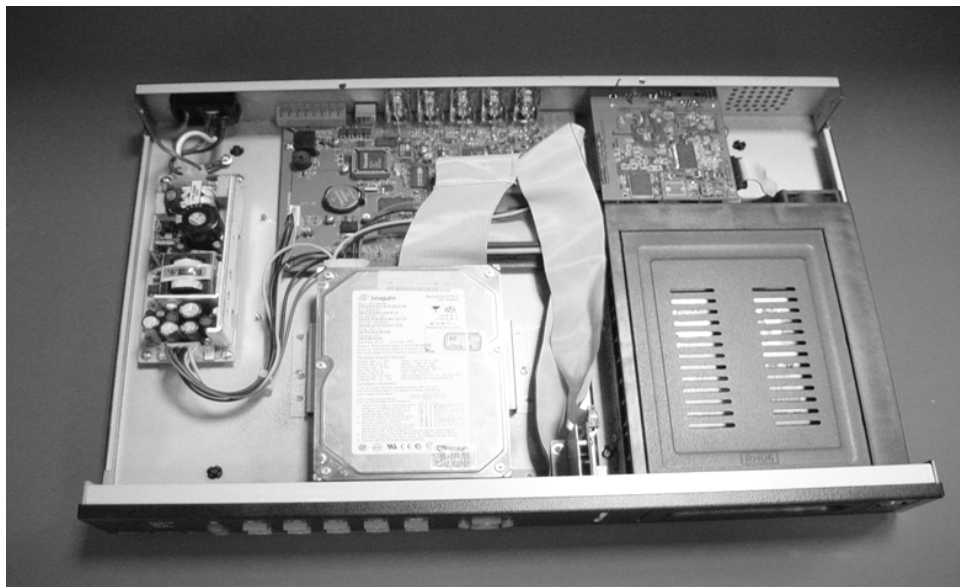

7. Restore top cover then hook up with power and monitor a hard drive status message will appear if it's been installed successful.
8. Up with power and monitor a hard drive status message will appear if it's been installed successful.

Attentions :

1. Hard drive master and slave mode must be set correctly.
2. Primary hard drive must be set as master and slave for secondary.
3. Make sure power cable is unplugged before hard drive installation starts.
4. IDE cable and power cable must be hooking up correctly.

